

# FinishLynx Championship Package Quick Start Guide

For EtherLynx Vision Cameras

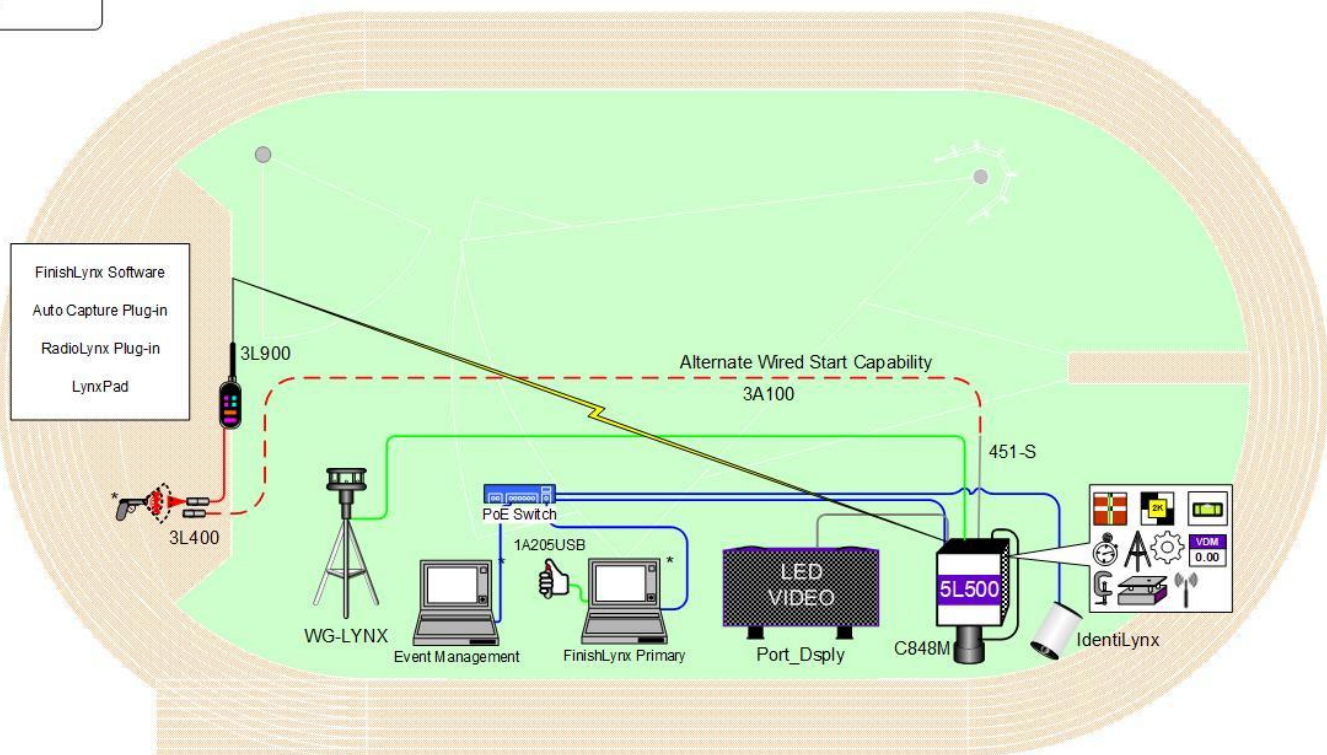

## Athletics – Championship



\* Computers and starting pistol not included in package

© 1992 – 2025 | Lynx System Developers, Inc. | www.finishlynx.com

Download a copy:



Contact Technical Support:

**Email:** support@finishlynx.com

**Phone:** 978-556-978











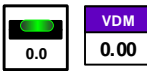











Join Us Online:

**Timer's Group:** facebook.com/groups/finishlynx

**Facebook:** facebook.com/finishlynx

**Instagram:** @finishlynx

Please verify that your FinishLynx Championship System contains all the components pictured here. If something is missing, or if you have questions about setting up your system after following this quick start guide, call: 1-800-989-LYNX. For additional tech support documents and downloads, visit [www.finishlynx.com/support/](http://www.finishlynx.com/support/)

Item	Description	Part #	Item	Description	Part #
	Carrying Case	1A207		Internal Level and Video Display Module	5LLEVEL 5LVDM
	EtherLynx Vision high sensitivity camera	5L500		Normally closed start sensor with light	3L400
	Timer-Enabled option for 5L500 camera	5LTE		500 ft. start sensor cable	3A100
	High Resolution option for 5L500 camera	5LHR		DB15 to XLR Connection cable	451-S
	Internal RadioLynx	Int-3L900		25 ft. Ethernet cables (x2)	C10BT-25
	C-Mount 8-48mm f1.2 Motorized Zoom Lens	C848M		2 x 100 ft. Ethernet cable	C10BT-100
	CS Mount 2.8-10mm P-Iris lens	CS2810P		Capture button	1A205USB
	CS Mount to C Mount Adapter	MCS-C		IdentifyLynx Full Frame Video Camera kit	SR-IdentifyLynx
	Remote positioner	2L102		Sonic Wind Gauge with Tripod and 50m cable	WG-Lynx
	Geared head	BG3275		8 port 10/100/1000 Power over Ethernet switch	PoE-Switch
	Super head clamp	BG2909		Lynx Portable Display	Port_Dsply
	Camera tripod (x2)	BG3036		Lynx USB Flash Drive with FinishLynx32, LynxPad, and ACM/RadioLynx Plugins	5LSW, 5LPRL, 5LACM and 9LSW01
<p><b>Be sure to keep your USB flash drive safe. It includes your Serial Numbers, Software, &amp; Quick-Start Guides. To access the files, insert the flash drive in your computer and click on <a href="#">START.html</a></b></p>					

## Items Not Included

- **Laptop or netbook** computer running Microsoft Windows. Your computer needs: 1 available USB port and 1 available Ethernet port.
- **Printer** (optional)

## Introduction

In this QSG, you will learn how to configure the FinishLynx network, set up the EtherLynx Vision camera and align it with the finish line using the remote positioner and remote lens. You will also learn how to capture, evaluate, and print a FinishLynx results image, configure FinishLynx to work with the scoreboard, and import a start list created in LynxPad.

### Step 1: Go to the Track

Bring your FinishLynx system (and an assistant) to the track. Make sure there is **power** available for your computers and for the Power over Ethernet switch. The EtherLynx Vision camera and the IdentiLynx camera will receive their power via the Ethernet data cables.

Set up a table near the finish line, ideally on the infield if power is available. The finish line should have black lane markers painted or taped on the finish. If not, we suggest you use black matte tape to designate lane lines. This will help you align the camera and get clearer images.

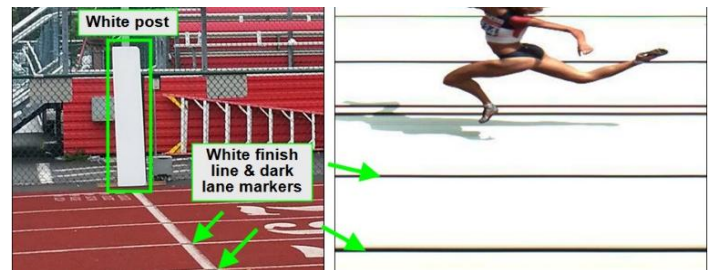

### Step 2: Install the Software

#### A. FinishLynx Software & Plugins

Insert the Lynx USB flash drive in your computer and click on **START.html** to access the software installers and serial numbers. You can also download the latest version of FinishLynx on our website:

[www.finishlynx.com/product/software/finishlynx-results-software/](http://www.finishlynx.com/product/software/finishlynx-results-software/)

Install FinishLynx, the RadioLynx Plug-in and Automatic Capture Mode (ACM) Plugin from the flash drive. When prompted, enter the serial numbers found inside the flash drive.

- 1) Start FinishLynx by clicking the Windows **Start** button and selecting **FinishLynx**.
- 2) Verify that you have correctly installed the ACM and RL Plug-ins by clicking **Help** from the Menu bar and

selecting **About...** When the **About FinishLynx** dialog appears, the ACM and RL Plug-ins are listed with the serial numbers you entered during installation.

#### B. LynxPad

Install using the Lynx USB Flash Drive or download the latest version of LynxPad at:

[www.finishlynx.com/product/event-management/lynxpad/](http://www.finishlynx.com/product/event-management/lynxpad/)

Follow the instructions on your screen to install LynxPad. When prompted, enter the serial number found on the flash drive.

**Note:** **Right-Click** on the installer and select **Run as Administrator** to install LynxPad. If you do not, you will not be able to print from LynxPad.

### Step 3: Evaluate a Sample Image

1. Start FinishLynx. Click **File | Open...**
2. Double-click **Sprint.evn** to open the sample event.

**Note:** This sample is a two-camera image. Your Championship System uses only one line-scan camera and produces single-camera images.

3. Click the mouse once on the torso of a competitor on the left side of the screen. A red hairline appears. Enter the lane number for the athlete in the identification box.
4. Press the **Enter** key on your computer. The finisher's time appears in the start list above the image.
5. Repeat these steps for all the competitors on the screen. You have just successfully evaluated a race in FinishLynx.
6. Click **File | Close window**. If you want to reuse the image later for practice evaluation, click **No** when asked to save your changes. Close FinishLynx.

## Step 4: Configure the Network for Windows 10 & 11

**Note: To be completed on both FinishLynx and Meet Management computer.**

1. Go to the Windows **Control Panel**. On the top right is **View By** with a drop-down arrow. Click the drop-down and choose Small or Large Icons.
2. Double-click on **Network and Sharing Center**. They are listed alphabetically by icon name.
3. This will open the **Network and Sharing Center**. On the left is a blue section titled Control Panel Home.
4. Click the **Change Adapter Settings** icon.
5. A new window will open displaying your network connections. Right-click **Wireless Network Connection** and select **Disable** from the list. This is only necessary for the FinishLynx Capture computer.
6. Right-click the **Local Area Connection** and select **Properties** from the list. A new window will appear with a list of connection items. Select **Internet Protocol Version 4 (TCP/IPv4)** and click the **Properties** button.
7. A Properties window will appear and is typically set to **Obtain an IP address automatically**. Select the radio button for **Use the following IP address**. In the box for IP address, enter 192.168.0.5 for FinishLynx and hit **Tab** key to auto fill in Subnet mask 255.255.255.0. Use 192.168.0.90 for LynxPad.
8. Click OK and navigate back to the Control Panel. In the control panel, click the Windows Firewall icon. Under Control Panel Home, on the left, click **Turn Windows Firewall on or off**.
9. Turn off both Home and Public Firewalls (Domain for Windows Pro).

## Step 5: Set Up the Camera and Tripod

Set up the tripod in line with the finish line, preferably on the infield and approximately **10 feet back**.

**Note:** Minimum recommended camera distance from track is eight feet (at this distance you may not be able to see the feet of the athlete in Lane 1 – being able to see the feet is not a requirement for accurate timing on the Torso of the athlete). If you need to be closer than this, you may have to use the optional 2.8-10mm lens supplied with your package.

1. Extend the tripod legs so the geared head is approximately 7 ft high.
2. On the near side of the finish line, hold a plumb bob so it is suspended directly above the middle of the finish line. This is the **plumb line**, shown as **a** in the image.
3. Tie string to the screw on the top of the tripod head. Have your assistant take the other end of the string to

the far side of the finish line and hold the string taut. This is the **sight line**, shown as **b** in the image below.

4. Move the tripod to the left or right until the plumb line and sight line touch at position **C** in the image below. The tripod is now in the plane of the finish line.

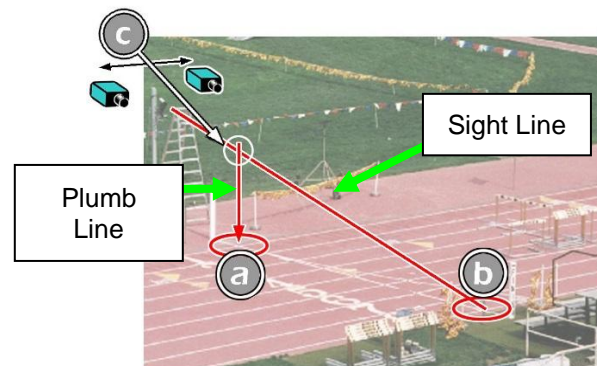

## Step 6: Attach the Camera to the Tripod

1. Secure the remote positioner to the camera bottom by turning the black handled thumbscrew. Make sure the FinishLynx label faces in the same direction as the camera lens will face.
2. Connect the cable that comes with the remote positioner to the port on the positioner and the port on the back of the camera labeled **Remote Control**.
3. Connect the cable on the remote lens to the remaining serial port on the remote positioner.
4. Secure the geared head to the top of the tripod.
5. Note how the mounting plate is attached to the top of the geared head. Then, pull back on the lever at the top of the geared head to release the mounting plate.
6. Tighten the mounting plate to the bottom of the remote positioner by turning the screw with a flathead screwdriver. Make sure the **Lens** marking on the bottom of the plate is facing the front of the remote positioner (where the Lynx label is affixed).
7. Attach the camera with the remote positioner and mounting plate to the tripod by clicking the mounting plate into place on the geared head.
8. With the camera lens lined up with and facing the finish line, make minor adjustments to the tripod legs so the bubble on the tripod is centered.
9. Turn the black knob on the geared head that controls the **tilt** of the camera so that it is at about a 30-degree angle to the ground.

**Step 7: Connect the Cables**

1. Connect an Ethernet cable between the back of the camera labeled **POE 10/100/1000** and a port on the Power over Ethernet switch.
2. Connect an Ethernet cable to the network connection on your computer and the other end to a port on the Power over Ethernet switch.

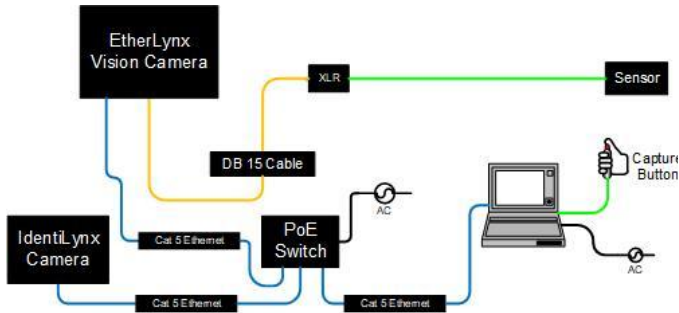

3. Connect DB15 to XLR Connection cable to the port on the back of the camera labeled Connection Box.
4. Connect the male end of the start sensor cable to the DB15 to XLR Connection cable. Attach the start sensor to the other end of the cable and keep the start sensor close by.
5. Connect the capture button cable to a USB port on the computer.
6. Turn on the camera by pressing the power button on the back panel.

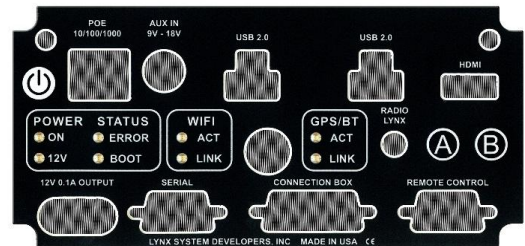

**Step 8: Align the EtherLynx Camera**

**Note:** The EtherLynx Vision camera can be aligned using either 1-D mode or 2-D EasyAlign mode. We recommend using EasyAlign. If you are using an older model EtherLynx camera, however, it must be aligned using classic 1-D mode.

**NOTE:** If running a wireless Ethernet card on your computer, we recommend that you disable it while the camera is booting.

**Start FinishLynx.** Wait while the green status bar in the lower right corner of the screen completes its cycle.

**Align Vision Camera in EasyAlign 2-D Video Mode**

1. **Activate EasyAlign** by clicking on the 2D align icon  in the top left-hand corner of the FinishLynx **Hardware Control** screen.

The icon turns green  and the 2-D video viewer appears within the software. The 2-D viewer makes it easy to see how your camera is aligned on the finish. **The goal is to align the green vertical line with the painted finish line and near its front edge.**

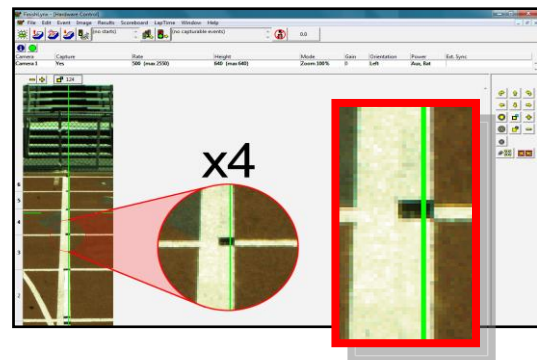

2. **Adjust Remote Lens/Positioner Controls** - Adjust the remote lens/positioner controls on the right of the FinishLynx hardware control screen.

**Center Remote Camera Positioner**

Click  to center the camera automatically using the remote positioner.

**Remote Camera Tilt, Pan & Swivel**

Use the remote **Tilt**, **Pan**, and **Swivel** buttons to adjust the orientation of the camera on the finish.

You want to ensure that the green vertical line is perfectly aligned on the white finish line, that the level indicator reads

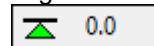

and that all lanes are visible in the viewer.

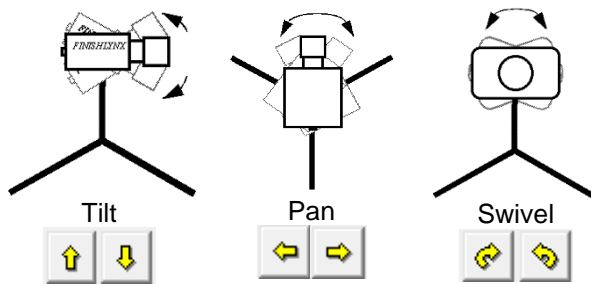



Have your assistant run through the finish line and watch where he/she appears on the computer monitor. The goal is for the runner's torso to be fully visible in both the inside and outside lanes. Once the camera's position is correct, you can then optimize the remote lens settings.

### Remote Iris (adjusts amount of light in lens)



Open or Close the remote iris to bring the ACM value as close to 1 as you can by clicking and holding the remote Iris buttons.

### Remote Focus (adjusts near/far image focus)

Click and hold the  and  buttons on the keypad on the right of the FinishLynx screen until the image becomes crisp. Start by focusing on the far lane and adjust until all lanes are in focus. Ensure that athletes in all lanes (near and far) are in focus.



**Note:** If you are having a hard time getting crisp focus, try opening your lens iris and allowing the AGC to drop closer to zero.

## Step 9: Adjust FinishLynx Camera Settings

- Click **Camera Settings Icon**  to open the Camera Settings dialog.
- Select the **Setup** tab:
  - Name:** enter a name to identify the camera(s)
  - Image Orientation:** select the correct orientation for finish (infield would be Left orientation)
  - Identify By:** select Lane for track **competition**.
  - Lanes:** enter the number of lanes on the track; the remaining should be left as default.
- Select the **Inputs** tab:
  - Start Sensor** is defaulted to **Closed** for the wired gun start. If **using** the RadioLynx, then set **Start Sensor** to **None** to turn off the wired start (they are independent of each other).
  - Photo Eye:** If **using** ACM to stop the scoreboard display, set it to **Internal**.
- Select the **RadioLynx** tab:
  - Port:** RadioLynx Port.
  - Setup ID:** should be 000 and select Start Sensor on the next line, **Name:** will fill in automatically with Start 000.
- Select the **Capture** tab:
  - Capture Method:** Select **Manual** if using the Capture Button or **Automatic** if using ACM plug-in (both **methods** can be active at the same time by selecting both).
- Click **OK** to close the **Camera Settings** and it is advised to restart the FinishLynx software.

## Step 10: Create a Shared Directory for FinishLynx and LynxPad

- Right-click on your computer desktop and select **New | Folder**. When the **New Folder** appears, change the name to **Practice competition**.
- In FinishLynx, click **File | Options....** Click the **Browse** button on the **Event Directory:** and navigate to the **Practice competition** directory you just created.

- Once the camera appears to be aligned, **Click**, the green alignment  icon to close 2D alignment and then click on the red 1-D alignment icon .

You will know when your camera is aligned on the finish line because the 1-D image will be primarily white. See image below for proper 1-D alignment.

If you followed the steps closely in 2-D align, the camera should already be aligned in 1-D mode as well. The 1-D image should look similar to the following screen capture:

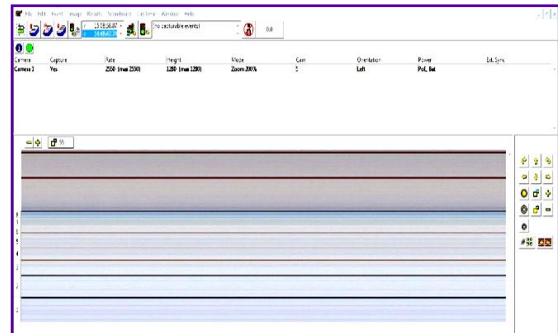

- Set White Balance
  - Right-click and draw a box around a small amount of the white image.
  - Click . White balance is now set.

- In FinishLynx, click the **Database** tab. Click the **Browse...** button next to the **Output Directory:** and navigate to the **Practice competition** directory. Then, click **Ok**.
- Click the Windows **Start** button then **LynxPad**.
- Click **File | Options...** and **uncheck** the **Load Existing Results on Program Start** box. Then, click **Ok**.
- Open the sample competition by clicking **File | Open**. Navigate to **C:\LynxPadData\Sample** then double-click the **lynx.cmp** file. A practice competition opens on the screen.
- Still in LynxPad, click **File | Options....** Click the **Browse** button next to the **Directory:** text field. Navigate to the **Practice competition** file you created earlier. Select it and click **Ok**. Click **Apply** then click **Ok**.
- Still in LynxPad, click **File | Save as...** and navigate to the **Practice competition** folder then click **Ok**. Now, FinishLynx can get start lists created in LynxPad, and LynxPad can import results generated by FinishLynx

### Step 11: Mount & Install IdentiLynx Camera

Follow the instructions on the separate [IdentiLynx QSG](#).

### Step 12: Setup RadioLynx Wireless Start

Follow instructions on the separate [Internal RadioLynx QSG](#).

### Step 13: Connect the Wind Gauge

- Connect the serial data cable supplied with the Wind Gauge to the DB9 port marked **Serial** on the Camera back panel.
- Connect the Red and Black banana plugs to the Red and Black sockets marked **12v output** on the Camera.

### Step 14: Configure Scoreboard Settings

- Follow the instructions on the [Lynx Portable Display Quick Start Guide](#)

### Step 15: Set Up Wind Gauge

**Note:** The EtherLynx Vision Camera should be powered on before starting the FinishLynx software – otherwise not all available Serial Ports will be visible in the drop-down menu.

- In FinishLynx, go to **File | Options**.
- Select the **Wind** tab.
- From the **Wind Module:** Drop-down list, select **Lynx**.
- In the **Serial Port** drop-down list, select [**Camera Name**] (**Body**).
- In the **Default Mode** drop-down list, select **100M**. Click **Ok**.
- Exit FinishLynx and then restart it to save the settings.

### Step 16: Automatic Capture Module (ACM) Setup and Operation

#### A: Using ACM to Stop Running Time

The following information will help to set up the ACM feature for stopping or pausing the running time with each race.

- In the Hardware Control window, click on the **Camera Settings** (blue circle with white "I" in upper left).
- In the Camera Settings, click on the **Inputs** tab and set **Photo Eye** to **Internal**.
- Click on the **Capture** tab and set **Capture Method** to **Automatic**. Click **OK** and close the Camera Settings.
- Click **File | Options** and select the **Scoreboard** tab.
- Confirm that the scoreboard is set up properly as shown above.

#### B: Manually Control ACM:

- Click **File | New** to create a new blank event or click on the **Create New Blank Event** button in the upper left.
- In the Event Window make sure there is an **A** for Armed and **S** for Scoreboard and it says **Armed** to the right of the race clock (when using ACM the C for capture will not show until capture is enabled).
- Create a start for the event and confirm that the running time is showing on the Lynx Portable Display.
- Click the Capture icon to enable capture then hit **Ctrl + F** and it will say Finishing to the right of the race clock (click on Scoreboard Menu for shortcut keys).
- Have someone run through the finish line and the camera should capture image and the running time should stop and display the time to the hundredths.

**Note:** In multi-lap races you can use **Alt + P** to pause the running time as competitors pass in front of the camera

**Step 17:** Use FinishLynx with LynxPad Data

1. In FinishLynx, click  to load the schedule of events from LynxPad. The **Go To Event** dialog appears.
2. Click the **Load Schedule** button once. Click the drop-down list under the **Load Schedule** button. A list of events appears. Select the “**110 Meter Hurdles Men (9, 3, 1)**” event in the list, and then click **Ok**. The first heat of the third round of the men’s 110m hurdles opens on the FinishLynx screen.
3. Either use a starting gun, or knock the sensor sharply against a hard object - this simulates the firing of the starting gun and starts the yellow FinishLynx timer.



4. Have your assistant run through the finish line while you press down and hold the red capture button to capture the image. Release the button as soon as he/she has run completely through the finish line.
5. Practice evaluating the image by following the same steps you followed earlier in Step 3.
6. Click **File | Save** to save the race to the **Practice competition** directory.

7. Crop space between competitors in your FinishLynx image by right-clicking and drawing a box around the unwanted space. Release the mouse button and select **Crop** from the dialog that appears.
8. **(Optional)** Print the results and a portion of the FinishLynx image by right-clicking on the image and drawing a box around the portion you want to appear in your printout. For example, the first place finisher or a close finish between two competitors. Click **Ok** and then select the printer from the **Print** dialog to send the image with results to the printer.
9. Click **File | Close window** and then click **Yes** to save changes you made to the FinishLynx image when you cropped it.
10. In LynxPad, click to highlight **Men 110 Meter Hurdles** in the **Events** window. The start list appears in the **Heats** window.
11. Still in LynxPad, click **Competition | Refresh All Results**. The results from the race you just evaluated appear in LynxPad.

Looking for more resources? Visit our YouTube Channel for setup and support videos:  
[www.youtube.com/finishlynx](http://www.youtube.com/finishlynx)

**Notes:**